



**READ ALL SAFETY INSTRUCTIONS BEFORE OPERATING THIS SIGNODE PRODUCT**

# **OPERATION, PARTS AND SAFETY MANUAL**

*It is the customer's responsibility to have all operators and servicemen read and understand this manual.*

## **ST TYPE STRAP TENSIONER**

Part No. 003480

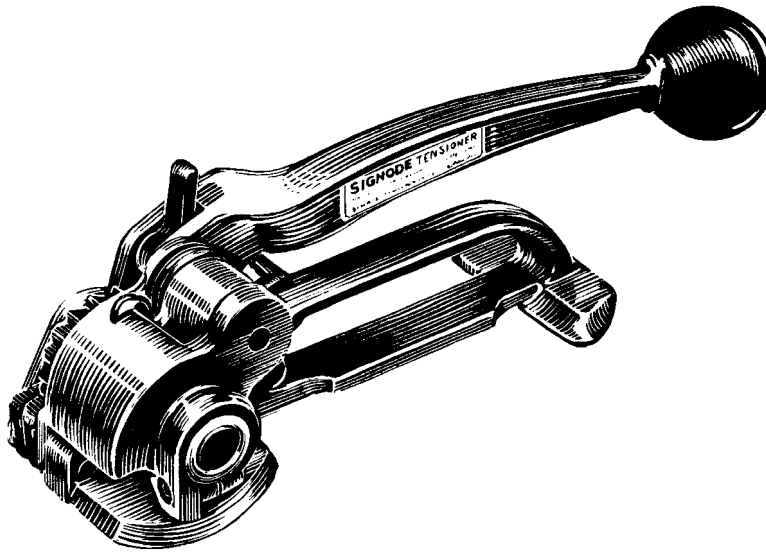

### **TOOL SPECIFICATIONS**

<b>STRAP TYPE</b>	<b>WIDTH</b>	<b>THICKNESS</b>
Apex, Magnus	3/8"(9.5mm) to 3/4"(19.0mm)	.015"(0.38mm) to .025"(0.63mm)

#### **PLEASE NOTE:**

Refer to Signode Operation, Parts & Safety Manual part number 186006 for additional part removal & replacement details and information.

**IMPORTANT - DO NOT DESTROY THIS MANUAL.** It is the customer's responsibility to have all operators and service personnel read and understand this manual. Contact your local Signode representative for additional copies of this manual.

# SAFETY INSTRUCTIONS

**GENERAL SAFETY INSTRUCTIONS - READ THESE INSTRUCTIONS CAREFULLY.  
FAILURE TO FOLLOW THESE INSTRUCTIONS CAN RESULT IN SEVERE PERSONAL INJURY.**

## GENERAL CONSIDERATIONS

### 1. EYE INJURY HAZARD.

Failure to wear safety glasses with side shields can result in severe eye injury or blindness. Always wear safety glasses with side shields which conform to ANSI Standard Z87.1 or EN 166.



### 2. STRAP BREAKAGE HAZARD.

Improper operation of the tool or sharp corners on the load can result in strap breakage during tensioning, which could result in the following:



! A sudden loss of balance causing you to fall.

! Both tool and strap flying violently towards your face.

Failure to place the strap properly around the load or on an unstable or shifted load could result in a sudden loss of strap tension during tensioning. This could result in a sudden loss of balance causing you to fall.

Read the tools operating instructions. If the load corners are sharp use edge protectors. Place the strap correctly around a properly positioned load.

! Positioning yourself in-line with the strap, during tensioning and sealing, can result in severe personal injury from flying strap or tool. When tensioning or sealing, position yourself to one side of the strap and keep all bystanders away.

! Using strap not recommended for this tensioner can result in strap breakage during tensioning. Use the correct Signode products for your application.

### 3. FALL HAZARD.

Maintaining improper footing and/or balance when operating the tool can cause you to fall. Do not use the tool when you are in an awkward position.

### 4. CUT HAZARD

Always wear protective gloves when handling strap or sharp parts.



### 5. TRAINING.

This tool must not be used by persons not properly trained in its use. Be certain that you receive proper training from your employer. If you have any questions contact your Signode Representative.

### 6. TOOL CARE.

Take good care of the tool. Inspect and clean it daily, lubricate it weekly. Replace any worn or broken parts.

### 7. WORK AREA

Keep work areas uncluttered and well lit.

### 8. CUTTING TENSIONED STRAP

Using claw hammers, crowbars, chisels, axes or similar tools will cause tensioned strap to fly apart with hazardous force. Use only cutters designed for cutting strap. Read the instructions in the cutters manual for proper procedure in cutting strap. Before using any Signode product read its operation and safety manual.

Several combinations of strap, seals and tools can be used with this tensioner. Use the correct Signode products for your application. If you need help contact your Signode Representative.

## SAFETY PROCEDURES FOR TOOL OPERATION

1. Before using this tensioner, read all the instructions in this Operation, Parts and Safety Manual.
2. NEVER HANDLE OR SHIP ANY LOAD WITH IMPROPERLY FORMED SEALS. Misformed seals may not secure the load and could cause serious injury. Inspect the tool for worn and/or damaged parts. Replace tool parts as needed.

If seals are not being properly formed:

- A. Ensure that the tool's operating instructions are being followed before applying another strap.
- B. Cut the strap off and apply another.

3. Tuck strap end back into the dispenser when not in use.

## MAINTENANCE/CLEANING

Debris accumulated in the teeth of either the feedwheel or the clutch plug must be removed with a small wire brush. A need to clean the teeth will become apparent when either the feedwheel skids on the strap or the lower strap slips on the clutch plug during tensioning.

## OPERATING INSTRUCTIONS

# **WARNING**

Wear safety glasses which conform to ANSI Standard Z87.1 or EN 166.

Always position yourself to one side of the strap while tensioning and sealing. Make sure all bystanders are clear before proceeding. Maintain proper footing and balance.

1. Encircle the package with strap as illustrated. Take up the slack, keeping the strap squarely in line.

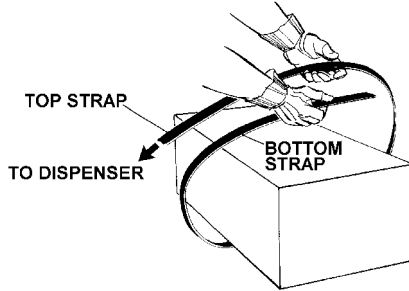

2. Hold the hand-tensioned strap in position with the left hand, grasp the tool in the right hand and squeeze the handle to the base to lift the feedwheel. Position the rear foot over the strap and slide the front foot under the overlapping ends, approximately 1" (25mm) ahead of the lower strap end. Make sure both straps have been fully inserted into the tool. The inner edges of the strap must butt up against the inner edge of the tool.

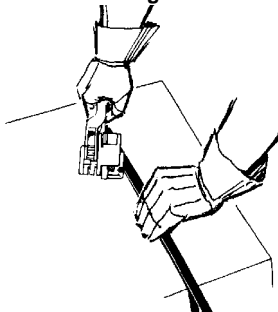

3. Release grip on tool to engage straps. Make sure the strap is in alignment with the tool. While standing to one side of the strap line, tension the strap through continuous up and down motions with the tensioning handle. **NOTE:** Do not allow the handle to press against the base during the downward portion of the tensioning cycle. This will raise the feedwheel and release the tensioned strap.

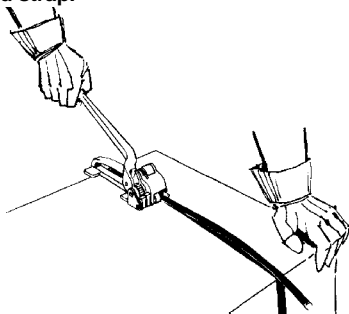

4. Snap a seal on the straps directly in front of the tool, making sure that the seal covers both straps.

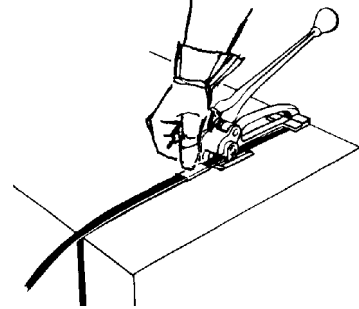

5. Hold the sealing tool at a right angle to the strap and rest it squarely over the seal. Seal the tensioned strap by bringing both sealer handles together as far as they will go.

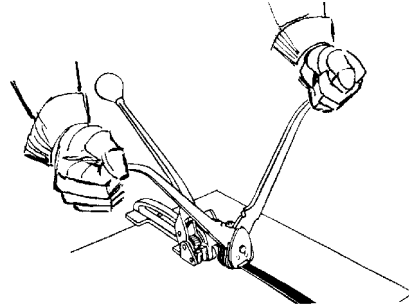

6. Return the handle to rest on the tool and press down on the handle pawl with thumb. Squeeze the handle to the base and remove the tool from the strap by swinging the rear foot out as illustrated.

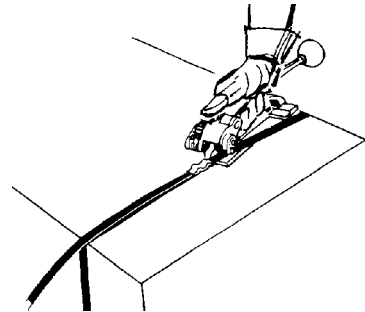

7. Excess strap is bent sharply back on the seal with the thumb or fingers. One and a half or two additional bends will result in a clean strap break off. If the width and gauge of the strap being used will not allow it to be bent, cut the excess strap as close to the seal as possible using an approved strap cutter.

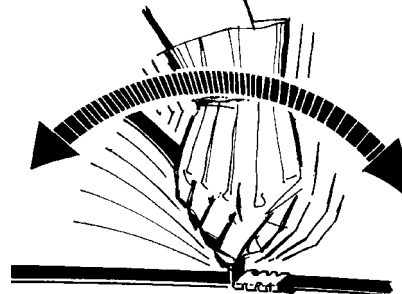

## ST TENSIONER PARTS LIST

KEY	QTY.	PART #	DESCRIPTION
1	1	273894	Handle assembly
3	1	003492	Handle pawl
4	1	003489	Handle pawl spring
5	1	003494	Handle pawl pin
6	1	003488	Ratchet gear
7	1	003490	Feedwheel support
8	1	003487	Feedwheel shaft
9	1	003478	Bearing
10	1	004502	SHCS, 10-32 x 5/8
11	1	003482	Feedwheel
12	1	003491	Support pin
13	1	003479	Support spring
14	1	003486	Retaining pawl pin
15	2	003483	Retaining pawl spring
16	1	003484	Long retaining pawl
17	1	003485	Short retaining pawl
18	2	001656	Strap guide pin
19	1	273748	Clutch plug assembly
20	1	001644	Lock wire
21	1	003497	Base
22	1	002471	Nameplate
23	1	003133	Caution plate
24	1	003493	Handle
25	1	306927	Knob
26	1	010057	Roll pin, 1/4 D x 1-3/4 LG
27	1	424250	Bushing
28	1	424251	BHCS, 1/4-28 x 1/4

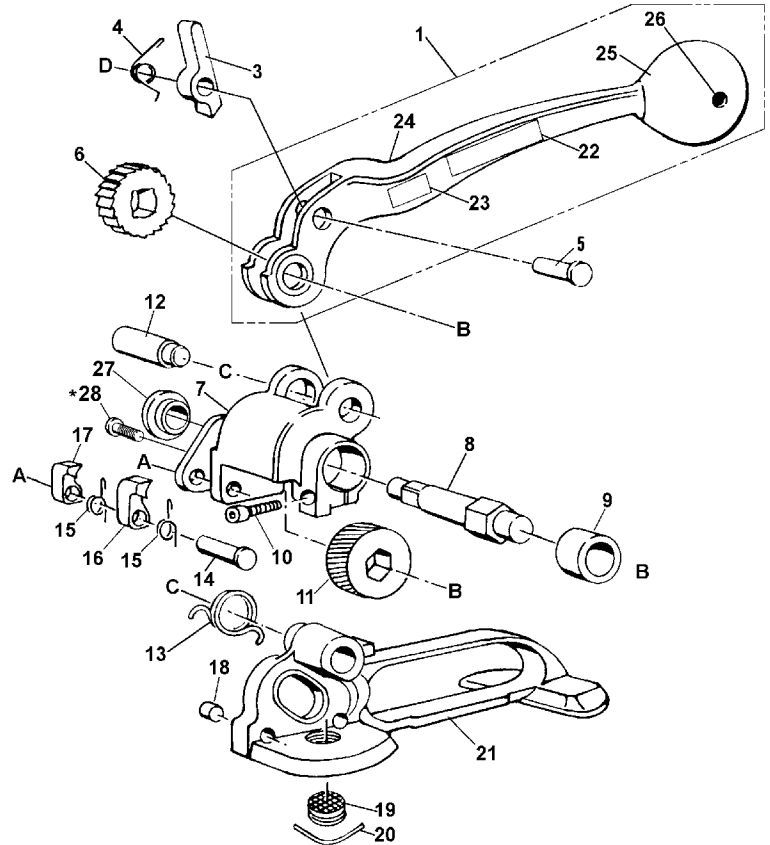

When ordering parts, please show tool model, part number, and description. All recommended spare parts are underlined and should be stocked.

\* Apply one drop of Loctite #271 (Red) or equivalent, available as Signode Part No. 422796.

NOTE: Keys numbers 8, 27 and 28 can be ordered together as Gear Housing Kit, Signode part No. 424436

**WARNING** All parts must be periodically inspected and replaced if worn or broken. Failure to do this can affect a product's operation and can result in personal injury.

## CLUTCH PLUG ADJUSTMENT

1. Remove the lock wire (Key 20) with needle nose pliers.
2. Using a flat head screwdriver, tighten the clutch plug (19) so that it touches the feedwheel. Then back it off one groove to align it with the lock wire holes in the tool base. Be sure the clutch plug and the feedwheel do not touch.
3. Replace the lock wire over the grooves in the clutch plug and hammer flat. To be sure the lock wire is secure, place a screwdriver across the center of the lock wire and tap once more.

